

IMAX B6AC 80W

Professional Balance Charger/Discharger



USER'S MANUAL

CONTENTS

What's New In IMAX B6AC.....	1
FOREWORD.....	1
Specifications.....	1
Special features.....	2
Charger layout.....	4
Lithium polymer balance charge program connection diagram.....	5
Warning and safety noets.....	5
Program flow chart.....	10
Safe timer calculation.....	13
Lithium(LiIo/LiPo/LiFe/LiHV).....	13
Charging of lithium battery.....	14
Charging lithium battery in the balance mode.....	14
Individual cell connection diagram(pin-assignment of 8-pin).....	15
Fast charging of lithium battery.....	15
Storage control of lithium battery.....	15
Discharging of lithium battery.....	16
Voltage balancing and monitoring in the discharge process.....	16
Charging/Discharging of NiCd/NiMH battery.....	17
Pb battery program.....	18
Data storage program.....	19
Various information in the program.....	20
Warning and error information.....	21
Warranty and service.....	22

What's New In IMAX B6AC

- ◆ Max charge current reach to 7A instead of 6A, that means it can speed up your charge by increasing the charge current.
- ◆ Max balance current increase to 460mA from 300mA, that means it can speed up your balance charge of your lithium batteries.

FOREWORD

Thank you purchasing the IMAX B6AC 80W Balance charger. This product is a rapid charger with a high performance microprocessor and specialized operating software. Please read this entire operating manual completely and attentively before using this product, as it covers a wide range of information on operating and safety. Or please do use this product in company with a specialist!

Specifications

Operating voltage range:	DC11.0~18.0 Volt AC 100~240V AC to DC adaptor(DC11.0~18.0V)
Circuit power:	Max.charge power 80W [DC Input] Max.discharge power 10W
Charge current range:	0.1~7.0A
Discharge current range:	0.1~2.0A
Current drain for balancing Li-po:	460mAh/cell
NiCd/NiMH battery cell count:	1~15 cell
Li-ion/Polymer cell count:	1~6 series
Pb battery voltage:	2V~20V
Weight:	531g(Net Weight)
Dimensions:	134X142X36mm

SPECIAL FEATURES**Optimized operating software**

IMAX B6AC features the so-called AUTO function that set the feeding current during the process of charging or discharging. Especially for Lithium batteries, it can prevent the overcharging which may lead to an explosion due to the user's fault. It can disconnect the circuit automatically and alarm once detecting any malfunction. All the programs of this product were controlled through two way linkage and communication, to achieve the maximum safety and minimized the trouble. All the settings can be configured by users!

Internal independent lithium battery balancer

IMAX B6AC employs an individual-cell-voltage balancer. It isn't necessary to connect an external balancer for balance charging.

Balancing individual cells battery discharging

During the process of discharging, IMAX B6AC can monitor and balance each cell of the battery individually. Error message will be indicated and the process will be ended automatically if the voltage of any single one cell is abnormal.

Adaptable to various type of lithium battery

IMAX B6AC is adaptable to various types of Lithium batteries, such as Li-ion, LiPo, LiFe and the new LiHV series of batteries.

Fast and storage mode of lithium battery

Purposes to charge Lithium battery varies, "fast" charge reduce the duration of charging, whereas "store" state can control the final voltage of your battery, so as to store for a long time and protect useful time of the battery.

IMAXB6AC 80W

Maximum safety

Delta-peak sensitivity: The automatic charge termination program based on the principle of the Delta-peak voltage detection. When the battery's voltage exceeds the threshold, the process will be terminated automatically.

Capacity limit

The charging capacity is always calculated as the charging current multiplied by time. If the charging capacity exceeds the limit, the process will be terminated automatically when you set the maximum value.

Temperature threshold*

The battery's internal chemical reaction will cause the temperature of the battery to rise. If the temperature limit is reached, the process will be terminated.

*This function is available by connecting optional temperature probe, which is not included in our package.

Processing time limit:

You can also limit the maximum process time to avoid any possible defect.

Input power monitoring

To protect the car battery used as DC input power from being damaged, its voltage keeps being monitored. If it drops below the lower limit, the process will be ended automatically.

Memory storage/load

The last 20 charging/discharging program settings are automatically saved in the charger's internal memory, and can be called out at any time.

Battery Cycling

Supports 1-5 times automatic cycling for battery refreshing and balancing, in order to maintain your battery's optimal performance.

Charger layout

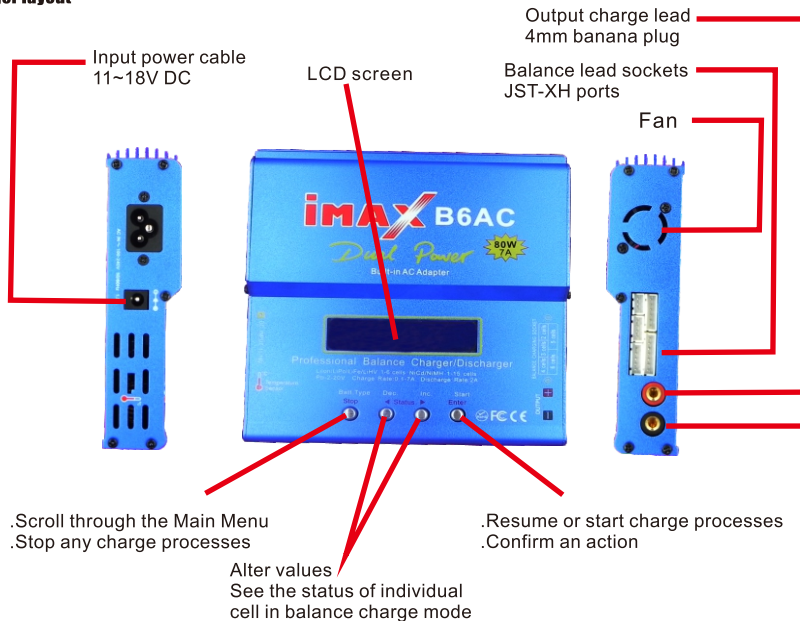

IMAX B6AC 80W

LITHIUM POLYMER BALANCE CHARGE PROGRAM CONNECTION DIAGRAM

This diagram shows the correct way to connect your battery to the IMAX B6AC charger while charging in the balance charge program mode only.

⚠ WARNING:

Failure to connect as shown in this diagram will damage this charger.



The main battery leads must be connected along with the balance lead connector as shown before charging your battery.

⚠ WARNING:

⚠ If using crocodile clips as shown in above diagram, make sure they are unable to touch together!

⚠ WARNING AND SAFETY NOTES

These warnings and safety notes are particularly important. Please follow the instructions for maximum safety; otherwise the charger and the battery can be damaged or at worst it can cause a fire.

- ⚠ Never leave the charger unattended when it is connected to its power supply. If any malfunction is found, **TERMINATE THE PROCESS AT ONCE** and refer to the operation manual.
- ⚠ Keep the charger well away from dust, damp, rain, heat, direct sunshine and vibration. Never drop it.
- ⚠ The allowable input voltage is 11-18V DC
- ⚠ This charger and the battery should be put on a heat-resistant, nonflammable and nonconductive surface. Never place them on a car seat, carpet or similar. Keep all the inflammable volatile materials away from operating area.
- ⚠ Make sure you know the specifications of the battery to be charged or discharged to ensure it meets the requirements of this charger. If the program is set up incorrectly, the battery and charger may be damaged. It can cause fire or explosion due to over charging. This warranty is not valid for any damage or subsequent damage arising as a result of a misuse or failure to observe the procedures outlined in this manual.

NiCd/NiMH

Voltage level: 1.2V/cell

Allowable fast charge current: 1C-2C (depends on the performance of cell)

Discharge voltage cut off level: 0.85V/cell (NiCd), 1.0V/cell (NiMH)

Li-ion Voltage level: 3.6V/cell

Max. charge voltage: 4.1V/cell

Allowable fast charge current: 1C or less

Min. discharge voltage cut off level: 2.5V/cell or higher

LiPo Voltage level: 3.7V/cell

Max. charge voltage: 4.2V/cell

Allowable fast charge current: 1C or less

Discharge voltage cut off level: 3.0V/cell or higher

LiHV Voltage level:3.8V/cell

Max.charge voltage:4.35V/cell
Allowable fast charge current:1C or less
Discharge voltage cut off level:3.1V/cell or higher

LiFe Voltage level:3.3V/cell

Max.charge voltage:3.6V/cell
Allowable fast charge current:4C or less
Discharge voltage cut off level:2.0V/cell or higher

Pb Voltage level:2.0V/cell

(Lead-acid)Max.charge voltage:2.46V/cell
Allowable fast charge current:0.4C or less
Discharge voltage cut off level:1.75V/cell or higher



Never attempt to charge or discharge the following types of batteries.

- A battery pack which consists of different types of cells(including different manufacturers)
- A battery that is already fully charged or just slightly discharged.
- Non-rechargeable batteries(Explosion hazard).
- Batteries that require a different charge technique from NiCd,NiMh,LiPo or Gel ell(Pb,Lead acid).
- A faulty or damaged battery.
- A battery fitted with an integral charge circuit or a protection circuit.
- Batteries installed in a device or which are electrically linked to other components.
- Batteries that are not expressly stated by the manufacturer to be suitable for the currents the charger delivers during the charge process.

- ❗ **To avoid short circuit between the charge lead always connect the charge cable to the charger first, then connect the battery. Reverse the sequence when disconnecting.**
- ❗ **Do not connect more than one battery pack to this charger at any one time.**
- ❗ **Please bear in mind the following points before commencing charging:**

Did you select the appropriate program suitable for the type of battery you are charging?

Did you set up adequate current for charging or discharging?

Have you checked the battery voltage? Lithium battery packs can be wired in parallel and in series, i.e. a 2 cell pack can be 3.7V (in parallel) or 7.4V (in series).

Have you checked that all connections are firm and secure? Make sure there are no intermittent contacts at any point in the circuit.

❗ **Charging**

During charge process, a specific quantity of electrical energy is fed into the battery. The charge quantity is calculated by multiplying charge current by charge time. The maximum permissible charge current varies depending on the battery type or its performance, and can be found in the information by the battery manufacturer. Only batteries that are expressly stated to be capable of quick-charge are allowed to be charged at rates higher than the standard charge current.

Connect the battery to the terminal of the charger: red is positive and black is negative. Due to the difference between resistance of cable and connector, the charger can not detect resistance of the battery pack, the essential requirement for the charger to work properly is that the charge lead should be of adequate conductor cross-section, and high quality connectors which are normally gold-plated should be fitted to both ends.

Always refer to the manual by the battery manufacturer pertaining to charging methods, recommended charging current and charging time. Especially, the Lithium battery should be charged according to the charging instruction provided by the manufacturer strictly.

Attention should be paid to the connection of Lithium battery especially.

Do not attempt to disassemble the battery pack arbitrarily.

Please get highlighted that Lithium battery packs can be wired in parallel and in series. In the parallel connection, the battery's capacity is calculated by multiplying single battery's capacity by the number of cells with total voltage stay the same. The voltage's imbalance may cause fire or explosion. Lithium battery is recommended to charge in series.



Discharging

The main purpose of discharging is to clean residual capacity of the battery, or to reduce the battery's voltage to a defined level. The same attention should be paid to the discharging process as charging. The final discharge voltage should be set up correctly to avoid deep-discharging. Lithium battery can not be discharged to lower than the minimum voltage, or it will cause a rapid loss of capacity or a total failure. Generally, Lithium battery doesn't need to be discharged. Please pay attention to the minimum voltage of Lithium battery to protect the battery.

Some rechargeable batteries have a memory effect. If they are partly used and recharged before the whole charge is accomplished, they remember this and will only use that part of their capacity next time. This is a "memory effect" it is said that NiCd and NiMH batteries are suffering from memory effect. NiCd has more memory effect than NiMH.

Lithium batteries are recommended to be discharged partially rather than fully discharged. Frequent full discharging should be avoided if possible. Instead, charge the battery more often or use a battery of larger capacity. Full capacity cannot be used until it has been subjected to 10 or more charge cycles. The cyclic process or charge and discharge will optimize the capacity of battery pack.

! Program flow chart

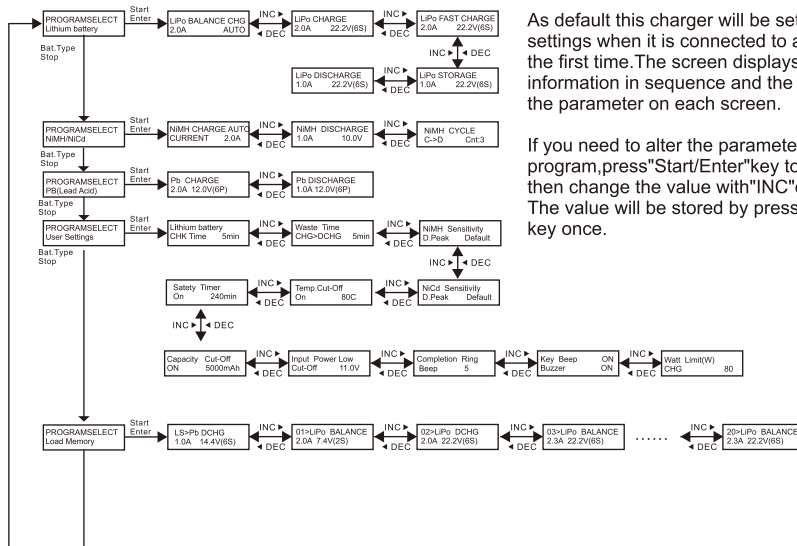

As default this charger will be set to typical user settings when it is connected to a 12V battery for the first time. The screen displays the following information in sequence and the user can change the parameter on each screen.

If you need to alter the parameter value in the program, press "Start/Enter" key to make it blink then change the value with "INC" or "DEC" key. The value will be stored by pressing "Start/Enter" key once.

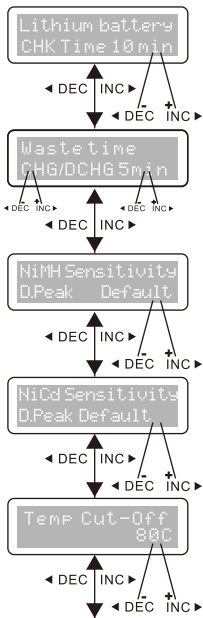

To avoid from erroneous setting by users, IMAxB6AC detects the cell count of Lithium battery automatically at the beginning of charge or discharge process. However, battery that is deep-discharged may take longer to be detected correctly. This option sets the check time allowed for the processor to verify the cell count.

Normally, 15 seconds are enough to detect the cell count correctly. Longer time is needed for the battery with large capacity. Avoid using long check time for batteries with small capacity. Extend the check time if the processor detects the cell count incorrectly at the beginning of charge or discharge process. Otherwise, using the default value is recommended.

The battery becomes warm after cycles of charge/discharge process. The program will insert a time delay after each charge/discharge process to allow the battery enough time to cool down before beginning next cycle of charge/discharge process. The valid value ranges from 1 to 60 minutes.

The screen shows the cut-off temperature of Lithium battery. you can press "DEC" or "INC" to select the cut-off temperature (Temp. Rang: 20~80°C). The maximum temperature of the battery can be set during the charge process. The process will be terminated automatically to protect battery once the temperature of battery reaches this value. This feature is accomplished through temperature probe (optional).

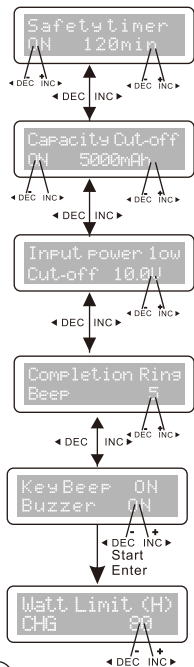

When the charge process starts, the integrated safety timer starts to run simultaneously. If error detected or the termination circuit can not detect whether the battery is fully charged or not, this unit is programmed to prevent overcharging. Please refer to the below statement to calculate the timer you set.

The program provides maximum capacity protection function. If the Delta-peak voltage can not be detected or the safety timer times out, the charge process will stop automatically, when the battery reaches the user-set maximum charge capacity.

This function monitors the voltage of the input battery used to power this charger. If the voltage is lower than user-set value, the program will end forcibly to protect the input battery.

The beep to confirm users' operation sounds every time a button is pressed. The beep or melody sounds at various times during operation to confirm different mode change. These functions can be switched on or off.

Safe timer Calculation

When charging NiCd or NiMH batteries , divide the capacity by current,then divide the result by 11.9, set this number of minutes as the value for safety timer setting . If the charger stopped at this time threshold , about 140% of the capacity will have been fed into the battery.

For example:

Capacity	Current	Safety Time
2000mAh	2.0A	$(2000/2.0=1000)/11.9=84$ minutes
3300mAh	3.0A	$(3300/3.0=1100)/11.9=92$ minutes
1000mAh	1.2A	$(1000/1.2=833)/11.9=70$ minutes

Lithium (LiIo/LiPo/LiFe/LiHV) program

The program is only suitable for charging/discharging Lithium-polymer batteries with a nominal voltage of 3.3/ 3.6/3.7V / 3.8/cell. Different batteries have different charge technique. There are two methods termed as constant voltage and constant current. The charge current varies according to battery capacity and specification. The final voltage is very important;it should precisely match the voltage of the battery:LiPo is 4.2V,LiIo is 4.1V,LiFe is 3.6V,LiHV is 4.35V.The current and voltage of the battery should be correctly set.

Charging of lithium battery

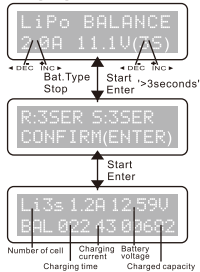

The left side of the first line shows the type of battery you choose. The value on the left of the second line of the charger is current user set. After setting the current and voltage, press "Start/Enter" key for more than 3 seconds to start the process. (charge current: 0.1-8.0A, voltage: 1-5V)

This displays the number of cells you set up and the processor detects. "R" shows the number of cells detected by the charger and "S" is the number of cells set by you at the previous screen. If both numbers are identical you can start charging by press "Start/Enter" button. If not, press "Batt./stop" button to go back to previous screen to carefully check the number of cells of the battery pack before going ahead.

This screen shows the real-time status during charge process. Press "Batt./Stop" key once to stop the charge process.

Charging Lithium battery in the balance mode

This function is for balancing the voltage of Lithium-polymer battery cells while charging. In the balance mode, the battery needs to have a balance lead to connect to the individual port at the right side of the charger. And you need to connect the battery's output plug to the output of charger. Charging in this mode is different from the normal modes, because the built-in processor monitors voltage of individual cell and control input current fed into each cell to normalize the voltage.

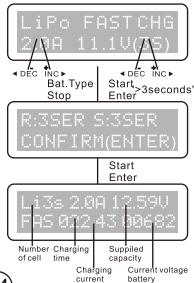

The value on the left side of the second lines sets the charge current. The value on the right side of the second lines sets the battery pack's voltage. After setting current and voltage, press "Start/Enter" for more than 3 seconds to start the process.

This displays the number of cells you set up and the processor detects. "R" shows the number of cells detected by the charger and "S" is the number of cells set by you at the previous screen. If both numbers are identical you can start charging by press "Start/Enter" button. If not, press "Batt./Stop" button to go back to previous screen to carefully check the number of cells of the battery pack before going ahead.

This screen shows the real-time status during charge process. Press "Batt./Stop" key once to stop the charge process.

Individual Cell Connection Diagram (Pin-assignment of 4-pin and 7-pin JST-XH balance connector)

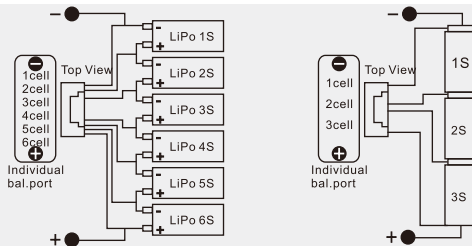

Fast charging of Lithium battery

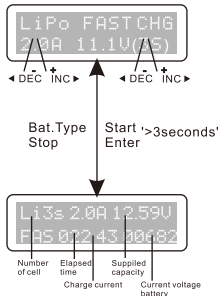

Charging current will become lower when it progress to the end of charging. A specific CV process will be reduced to end the charging process earlier. In fact, the charging current will go to 1/5 when the charging process comes to 1/10. Charging capacity will be a little smaller than normal charging, but charging time will be shortened accordingly.

You can set up the charging current and voltage of the battery pack. Press "Start/Enter" key to display voltage confirmation. Then press "Start/Enter" key again to confirm and begin to charge.

This screen shows the real-time status of "fast charging". Press "Batt. Type/ Stop" key once to stop the charge process.

Storage control of Lithium battery

This function is for charging/discharging batteries which are not used at once. This program is designed for charging or discharging of batteries of specific original state. They are classified by types: 3.75V Lilo, 3.85V LiPo, 4.00V LiHV and 3.3V LiFe. The program will begin to discharge if the original state of the battery exceeds the voltage level of storage.

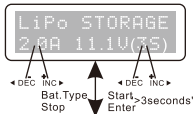

At this screen, you can set up the current and voltage of the battery pack. Charging and discharging will make the batteries come to the voltage level of "storage" state.

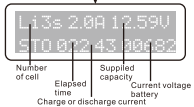

This screen shows the real-time status charging. Press "Batt. type/Stop" key once to stop the charge process.

Discharging of Lithium battery

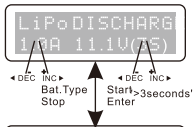

The value of discharge current on the left can not exceed 1C, and the value on the right can not be under the voltage recommended by the manufacturer to avoid deep discharging. Press "Start/Enter" for more than 3 seconds to start charging.

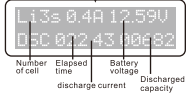

This shows the real-time status of discharging, you can press "Batt. Type/Stop" key to stop discharging.

Voltage balancing and monitoring in the discharge process

The processor monitors voltage of each cell when the battery packs are during its "storage" and "discharging" process. To achieve this feature, plug each battery to the charger individually. If voltage of any cell is abnormal, IMAX B6AC 80W will show error message and terminate the program forcibly. So if there is battery damage or disconnection, you can see the error message and press "INC?" to know which cell is damaged.

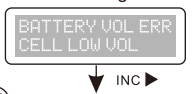

The processor detects voltage of one cell is too low.

```
4.14 4.16 4.09
2.18 0.00 0.00
```

The 4th cell was damaged. The value of voltage may be zero if disconnection occurs.

Charging of NiCd/NiMH battery

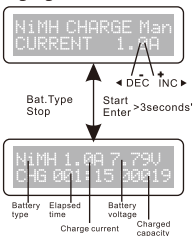

This program is for charging and discharging of NiCd/NiMH batteries associated with R/C models applications. You can press "Start/Enter" key to make it blink and then INC or DEC to change the parameter value. Press "Start/Enter" key to store the value.

This program charge the battery using the current you set up. In the "auto" state, you should set up the upper limit of the charge current to avoid damage by excessive feeding current. Some batteries of low resistance and capacity can lead to higher current in the "auto" charging mode. But in the manual mode, it will charge with the current you set. You can make it blink in the current field and press "INC" or "DEC" at the same time to switch mode.

The screen shows the real-time status. Press "Batt.type/Stop" key to end the program. The sound will emitted to indicates the end of program.

Discharge of NiCd/NiMH battery

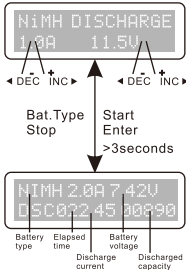

Set charge current on the left and the final voltage on the right. Range of the charge current is 0.1-2.0A; range of final voltage is 0.1-25.0V. Press "Start/Enter" key for more than 3 seconds to start the program.

The screen indicates the discharging state. You can press "Start/Enter" key to alter discharge current. Press "Start/Enter" again to store the value. Press "Batt.type/Stop" key to stop discharging. The emitted sound alerts the end of discharging.

Charge/discharge and discharge/charge cycle of NiCd/NiMH battery

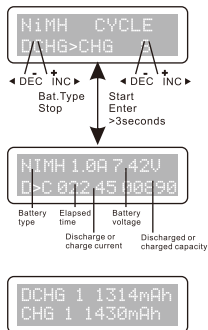

You can set up sequence on the left and the number of cycles on the right. You can balance, refresh and bread-in the battery with this function. You can set a temporary cool-off procedure in the use's setting.

Press "Batt.type/Stop" key to stop program, you can press "Start/Enter" key to alter charge current. The sound indicates the end of program.

When it approaches to the end, you can see the capacity of the battery being charged or discharged. You can press "INC▶" or "◀DEC" key to display result of each cycle.

Pb(lead-sulphuric acid)battery program

This program is only suitable for charging Pb (lead-acid) battery with nominal voltage from 2 to 20V. Pb (lead-acid) battery is completely different from NiCd / NiMH battery. These batteries can only deliver current lower in comparison to their capacity. The same restriction applies to the charging process. Consequently, the optimum charge current can only be 1/10 of the capacity. Pb battery can not be used for fast-charging, please follow the instructions provided by the battery manufacturer. You can press "Start / Enter" key to make it blink and alter the value of parameters using "INC▶" or "◀DEC" key, press "Start/Enter" key to store the value.

Charging of the Pb battery

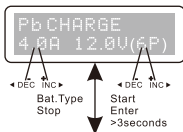

Set up the charge current on the left and nominal voltage on the right. Range of current is 0.1- 8.0A, the voltage should match the battery being charged. Press "Start/Enter" key for more than 3 seconds to start charging.

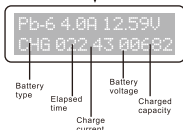

The screen displays the real-time discharging status. Press "Start/Enter" key to alter discharge current. Press "Start/Enter" key again to store the parameter value you set. Press "Batt.type/Stop" key to end the program.

Discharging of the Pb battery

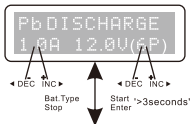

Set up the charge current on the left and nominal voltage on the right. Range of discharge current is 0.1 - 8.0A, the voltage should match the battery being charged. Press "Start/Enter" key for more than 3 seconds to start charging.

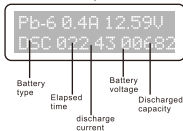

The screen displays the real-time discharging status. Press "Start/Enter" key to alter discharge current. Press "Start/Enter" key again to store the parameter value you set. Press "Batt.type/Stop" key to end the program.

Data storage program

For your convenience, IMAX B6AC 80W has a data storage function. It automatically stores the last 20 operation data, so you can call back the data when charging or discharging without setting up the program again.

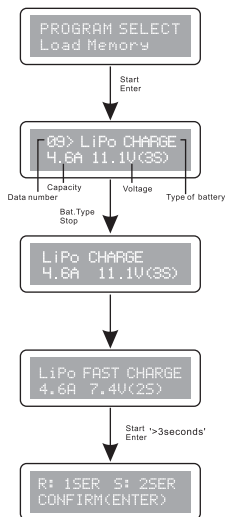

Select "Load Memory" from the main menu, then press "START".

Press "INC" or "DEC" to cycle through the saved profiles. There are memory slots 1 through 20, plus "LS", which automatically saves the last charging/discharging profile used.

Press "START/ENTER" to customize the saved profile. Here you can use the "START/ENTER" key to rotate between different settings. Press "INC"/"DEC" to change them, then press "START/ENTER" again to save.

Once the setup is complete, you can either press and hold "START/ENTER" to run the profile, or you can simply press "STOP" to save the profile and exit.

Various information in the program

You can inquire various information on the LCD screen during the charging and discharging process. Press ► "DEC" key, the charger will display user's setting. You can press ◀ "INC" key to monitor voltage of each cell while the battery is connected with each port of the charger.

Lilo/LiPo/LiFe/LiHV

```
End Voltage
12.6v(3S)
```

◀ DEC ▼

```
Capacity Cut-off
On 5000mAh
```

▼ INC ▶

```
Safety Timer
ON 200min
```

◀ DEC ▼

```
Temp Cut-off
```

◀ DEC ▼

```
Ext.Temp 26C
```

◀ DEC ▼

```
IN Power Voltage
12.56V
```

◀ DEC ▼

```
4.14 4.16 4.09
0.00 0.00 0.00
```

It comes to the final voltage when the program ended.

The battery is connected with each port through cable; you can check voltage of each cell in the battery pack. When the cable is connected with the ports on the right of the charger, the program will display voltage of up to 6 batteries. The battery pack needs an output connector connected with each cell.

The external temperature is displayed when the temperature probe is used.

3-pin connector is selected to be the USB port.

NiMH/NiCd

```
NiMH Sensitivity
D. Peak 7mV/Cell
```

◀ DEC ▼

```
IN Power Voltage
12.56V
```

◀ DEC ▼

```
Ext.Temp 26C
```

◀ DEC ▼

```
Temp Cut-off
```

◀ DEC ▼

```
Safety Timer
ON 200min
```

◀ DEC ▼

```
Capacity Cut-off
On 5000mAh
```

Warning and error information

IMAX B6 80W incorporates a variety of functions for the systems to verify processes and the state of the electronics. In case of an error the screen will display the cause of error and emit an audible sound.

REVERSE POLARITY	Incorrect polarity connected.
CONNECTION BREAK	Battery connection is interrupted.
SHORT ERR	Short-circuit of the output termination.
INPUT VOL ERR	Erroneous selection of voltage of Lithium pack, please check the voltage of the battery pack.
VOL SELECT ERR	The voltage of the battery pack has been selected incorrectly!
BREAK DOWN	The charger has malfunctioned for some reason. Seek professional advice.
BATTERY CHECK LOW VOLTAGE	The voltage is lower than which is set. Please check the number of cells in the battery pack.
BATTERY CHECK HIGH VOLTAGE	The voltage is higher than which is set. Please check the number of cells in the battery pack.

Warranty and service

We guarantee this product to be free of manufacturing and assembly defects for a period of one year from the time of purchase. The warranty only applies to material or operational defects, which are present at the time of purchase. During that period, we will repair or replace free of service charge for products deemed defective due to those causes.

You will be required to produce proof of purchase (invoice or receipt). This warranty is not valid for any damage or subsequent damage arising as a result of misuse, modification or as a result of failure to observe the procedures outlined in this manual.